

19 Weighted Bipartite Matching

Weighted Bipartite Matching/Assignment

- ▶ Input: undirected, bipartite graph $G = L \cup R, E$.
- ▶ an edge $e = (\ell, r)$ has weight $w_e \geq 0$
- ▶ find a matching of maximum weight, where the weight of a matching is the sum of the weights of its edges

Simplifying Assumptions (wlog [why?]):

- ▶ assume that $|L| = |R| = n$
- ▶ assume that there is an edge between every pair of nodes $(\ell, r) \in V \times V$

Weighted Bipartite Matching

Theorem 3 (Halls Theorem)

A bipartite graph $G = (L \cup R, E)$ has a perfect matching if and only if for all sets $S \subseteq L$, $|\Gamma(S)| \geq |S|$, where $\Gamma(S)$ denotes the set of nodes in R that have a neighbour in S .

19 Weighted Bipartite Matching

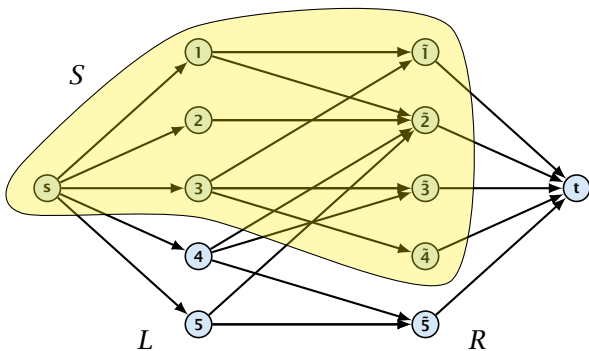

Halls Theorem

Proof:

- ← Of course, the condition is necessary as otherwise not all nodes in S could be matched to different neighbours.
- ⇒ For the other direction we need to argue that the minimum cut in the graph G' is at least $|L|$.

Let S denote a minimum cut such that $|E(S, L)| < |S|$.
For all $s \in S$ denote the set of neighbours of s by $N(s)$.
Clearly, all neighbours of s are in L because S is a cut.
Hence, $|E(S, L)| = \sum_{s \in S} |N(s)| < |S|$.
This gives a contradiction because $|L| \leq |E(S, L)|$.
Hence, the cut $E(S, L)$ is a minimum cut.

Halls Theorem

Proof:

- ⇐ Of course, the condition is necessary as otherwise not all nodes in S could be matched to different neighbours.
- ⇒ For the other direction we need to argue that the minimum cut in the graph G' is at least $|L|$.
 - ▶ Let S denote a minimum cut and let $L_S \triangleq L \cap S$ and $R_S \triangleq R \cap S$ denote the portion of S inside L and R , respectively.
 - ▶ Clearly, all neighbours of nodes in L_S have to be in S , as otherwise we would cut an edge of infinite capacity.
 - ▶ This gives $R_S \geq |\Gamma(L_S)|$.
 - ▶ The size of the cut is $|L| - |L_S| + |R_S|$.
 - ▶ Using the fact that $|\Gamma(L_S)| \geq |L_S|$ gives that this is at least $|L|$.

Halls Theorem

Proof:

- ⇐ Of course, the condition is necessary as otherwise not all nodes in S could be matched to different neighbours.
- ⇒ For the other direction we need to argue that the minimum cut in the graph G' is at least $|L|$.
 - ▶ Let S denote a minimum cut and let $L_S \stackrel{\text{def}}{=} L \cap S$ and $R_S \stackrel{\text{def}}{=} R \cap S$ denote the portion of S inside L and R , respectively.
 - ▶ Clearly, all neighbours of nodes in L_S have to be in S , as otherwise we would cut an edge of infinite capacity.
 - ▶ This gives $R_S \geq |\Gamma(L_S)|$.
 - ▶ The size of the cut is $|L| - |L_S| + |R_S|$.
 - ▶ Using the fact that $|\Gamma(L_S)| \geq |L_S|$ gives that this is at least $|L|$.

Halls Theorem

Proof:

- ⇐ Of course, the condition is necessary as otherwise not all nodes in S could be matched to different neighbours.
- ⇒ For the other direction we need to argue that the minimum cut in the graph G' is at least $|L|$.
 - ▶ Let S denote a minimum cut and let $L_S \stackrel{\text{def}}{=} L \cap S$ and $R_S \stackrel{\text{def}}{=} R \cap S$ denote the portion of S inside L and R , respectively.
 - ▶ Clearly, all neighbours of nodes in L_S have to be in S , as otherwise we would cut an edge of infinite capacity.
 - ▶ This gives $R_S \geq |\Gamma(L_S)|$.
 - ▶ The size of the cut is $|L| - |L_S| + |R_S|$.
 - ▶ Using the fact that $|\Gamma(L_S)| \geq L_S$ gives that this is at least $|L|$.

Halls Theorem

Proof:

- ⇐ Of course, the condition is necessary as otherwise not all nodes in S could be matched to different neighbours.
- ⇒ For the other direction we need to argue that the minimum cut in the graph G' is at least $|L|$.
 - ▶ Let S denote a minimum cut and let $L_S \stackrel{\text{def}}{=} L \cap S$ and $R_S \stackrel{\text{def}}{=} R \cap S$ denote the portion of S inside L and R , respectively.
 - ▶ Clearly, all neighbours of nodes in L_S have to be in S , as otherwise we would cut an edge of infinite capacity.
 - ▶ This gives $R_S \geq |\Gamma(L_S)|$.
 - ▶ The size of the cut is $|L| - |L_S| + |R_S|$.
 - ▶ Using the fact that $|\Gamma(L_S)| \geq L_S$ gives that this is at least $|L|$.

Halls Theorem

Proof:

- ⇐ Of course, the condition is necessary as otherwise not all nodes in S could be matched to different neighbours.
- ⇒ For the other direction we need to argue that the minimum cut in the graph G' is at least $|L|$.
 - ▶ Let S denote a minimum cut and let $L_S \stackrel{\text{def}}{=} L \cap S$ and $R_S \stackrel{\text{def}}{=} R \cap S$ denote the portion of S inside L and R , respectively.
 - ▶ Clearly, all neighbours of nodes in L_S have to be in S , as otherwise we would cut an edge of infinite capacity.
 - ▶ This gives $R_S \geq |\Gamma(L_S)|$.
 - ▶ The size of the cut is $|L| - |L_S| + |R_S|$.
 - ▶ Using the fact that $|\Gamma(L_S)| \geq |L_S|$ gives that this is at least $|L|$.

Halls Theorem

Proof:

- ⇐ Of course, the condition is necessary as otherwise not all nodes in S could be matched to different neighbours.
- ⇒ For the other direction we need to argue that the minimum cut in the graph G' is at least $|L|$.
 - ▶ Let S denote a minimum cut and let $L_S \stackrel{\text{def}}{=} L \cap S$ and $R_S \stackrel{\text{def}}{=} R \cap S$ denote the portion of S inside L and R , respectively.
 - ▶ Clearly, all neighbours of nodes in L_S have to be in S , as otherwise we would cut an edge of infinite capacity.
 - ▶ This gives $R_S \geq |\Gamma(L_S)|$.
 - ▶ The size of the cut is $|L| - |L_S| + |R_S|$.
 - ▶ Using the fact that $|\Gamma(L_S)| \geq |L_S|$ gives that this is at least $|L|$.

Algorithm Outline

Idea:

We introduce a node weighting \vec{x} . Let for a node $v \in V$, $x_v \geq 0$ denote the weight of node v .

Algorithm Outline

Idea:

We introduce a node weighting \vec{x} . Let for a node $v \in V$, $x_v \geq 0$ denote the weight of node v .

- ▶ Suppose that the node weights dominate the edge-weights in the following sense:

$$x_u + x_v \geq w_e \text{ for every edge } e = (u, v).$$

- ▶ Let $H(\vec{x})$ denote the subgraph of G that only contains edges that are **tight** w.r.t. the node weighting \vec{x} , i.e. edges $e = (u, v)$ for which $w_e = x_u + x_v$.
- ▶ Try to compute a perfect matching in the subgraph $H(\vec{x})$. If you are successful you found an optimal matching.

Algorithm Outline

Idea:

We introduce a node weighting \vec{x} . Let for a node $v \in V$, $x_v \geq 0$ denote the weight of node v .

- ▶ Suppose that the node weights dominate the edge-weights in the following sense:

$$x_u + x_v \geq w_e \text{ for every edge } e = (u, v).$$

- ▶ Let $H(\vec{x})$ denote the subgraph of G that only contains edges that are **tight** w.r.t. the node weighting \vec{x} , i.e. edges $e = (u, v)$ for which $w_e = x_u + x_v$.
- ▶ Try to compute a perfect matching in the subgraph $H(\vec{x})$. If you are successful you found an optimal matching.

Algorithm Outline

Idea:

We introduce a node weighting \vec{x} . Let for a node $v \in V$, $x_v \geq 0$ denote the weight of node v .

- ▶ Suppose that the node weights dominate the edge-weights in the following sense:

$$x_u + x_v \geq w_e \text{ for every edge } e = (u, v).$$

- ▶ Let $H(\vec{x})$ denote the subgraph of G that only contains edges that are **tight** w.r.t. the node weighting \vec{x} , i.e. edges $e = (u, v)$ for which $w_e = x_u + x_v$.
- ▶ Try to compute a perfect matching in the subgraph $H(\vec{x})$. If you are successful you found an optimal matching.

Algorithm Outline

Reason:

- ▶ The weight of your matching M^* is

$$\sum_{(u,v) \in M^*} w_{(u,v)} = \sum_{(u,v) \in M^*} (x_u + x_v) = \sum_v x_v .$$

- ▶ Any other matching M has

$$\sum_{(u,v) \in M} w_{(u,v)} \leq \sum_{(u,v) \in M} (x_u + x_v) \leq \sum_v x_v .$$

Algorithm Outline

What if you don't find a perfect matching?

Then, Hall's theorem guarantees you that there is a set $S \subseteq L$, with $|\Gamma(S)| < |S|$, where Γ denotes the neighbourhood w.r.t. the subgraph $H(\vec{x})$.

Idea: reweight such that:

- ▶ the total weight assigned to nodes decreases
- ▶ the weight function still dominates the edge-weights

If we can do this we have an algorithm that terminates with an optimal solution (we analyze the running time later).

Algorithm Outline

What if you don't find a perfect matching?

Then, Hall's theorem guarantees you that there is a set $S \subseteq L$, with $|\Gamma(S)| < |S|$, where Γ denotes the neighbourhood w.r.t. the subgraph $H(\vec{x})$.

Idea: reweight such that:

- ▶ the total weight assigned to nodes decreases
- ▶ the weight function still dominates the edge-weights

If we can do this we have an algorithm that terminates with an optimal solution (we analyze the running time later).

Algorithm Outline

What if you don't find a perfect matching?

Then, Hall's theorem guarantees you that there is a set $S \subseteq L$, with $|\Gamma(S)| < |S|$, where Γ denotes the neighbourhood w.r.t. the subgraph $H(\vec{x})$.

Idea: reweight such that:

- ▶ the total weight assigned to nodes decreases
- ▶ the weight function still dominates the edge-weights

If we can do this we have an algorithm that terminates with an optimal solution (we analyze the running time later).

Changing Node Weights

Increase node-weights in $\Gamma(S)$ by $+\delta$, and decrease the node-weights in S by $-\delta$.

- ▶ Total node-weight decreases.
- ▶ Only edges from S to $R - \Gamma(S)$ decrease in their weight.
- ▶ Since, none of these edges is tight (otw. the edge would be contained in $H(\vec{x})$, and hence would go between S and $\Gamma(S)$) we can do this decrement for small enough $\delta > 0$ until a new edge gets tight.

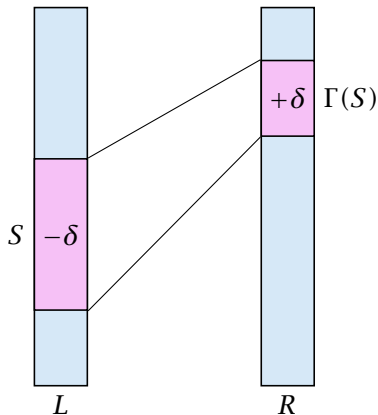

Changing Node Weights

Increase node-weights in $\Gamma(S)$ by $+\delta$, and decrease the node-weights in S by $-\delta$.

- ▶ Total node-weight decreases.
- ▶ Only edges from S to $R - \Gamma(S)$ decrease in their weight.
- ▶ Since, none of these edges is tight (otw. the edge would be contained in $H(\vec{x})$, and hence would go between S and $\Gamma(S)$) we can do this decrement for small enough $\delta > 0$ until a new edge gets tight.

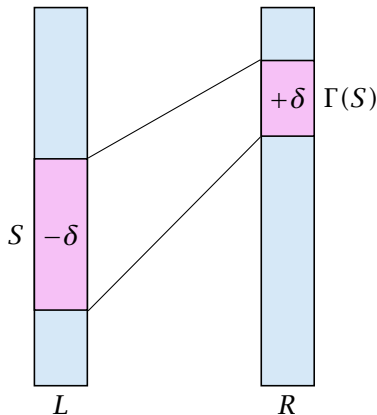

Changing Node Weights

Increase node-weights in $\Gamma(S)$ by $+\delta$, and decrease the node-weights in S by $-\delta$.

- ▶ Total node-weight decreases.
- ▶ Only edges from S to $R - \Gamma(S)$ decrease in their weight.
- ▶ Since, none of these edges is tight (otw. the edge would be contained in $H(\vec{x})$, and hence would go between S and $\Gamma(S)$) we can do this decrement for small enough $\delta > 0$ until a new edge gets tight.

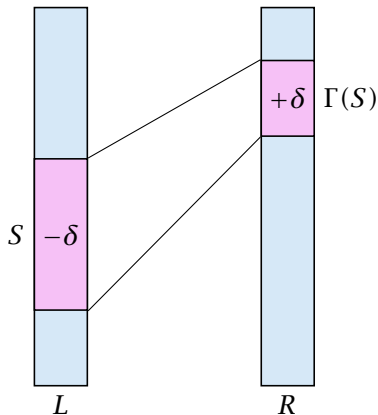

Changing Node Weights

Increase node-weights in $\Gamma(S)$ by $+\delta$, and decrease the node-weights in S by $-\delta$.

- ▶ Total node-weight decreases.
- ▶ Only edges from S to $R - \Gamma(S)$ decrease in their weight.
- ▶ Since, none of these edges is tight (otw. the edge would be contained in $H(\vec{x})$, and hence would go between S and $\Gamma(S)$) we can do this decrement for small enough $\delta > 0$ until a new edge gets tight.

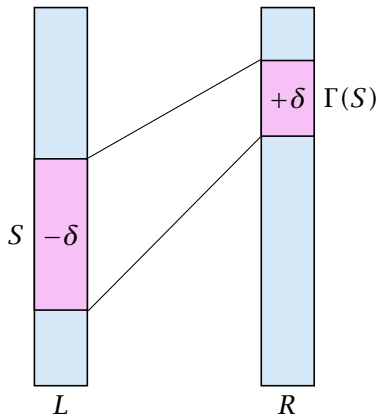

Weighted Bipartite Matching

Edges not drawn have weight 0.

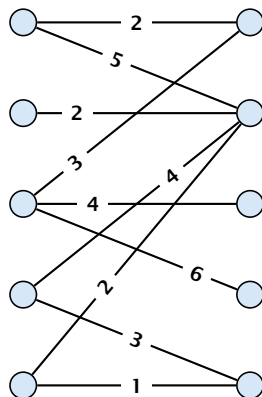

Weighted Bipartite Matching

Edges not drawn have weight 0.

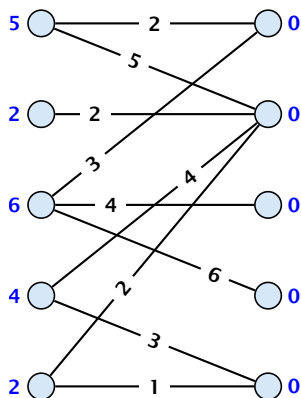

Weighted Bipartite Matching

Edges not drawn have weight 0.

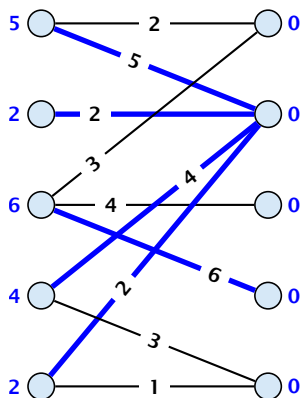

Weighted Bipartite Matching

Edges not drawn have weight 0.

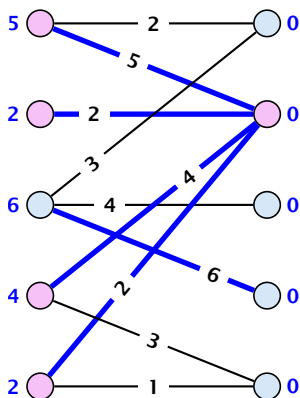

Weighted Bipartite Matching

Edges not drawn have weight 0.

$$\delta = 1$$

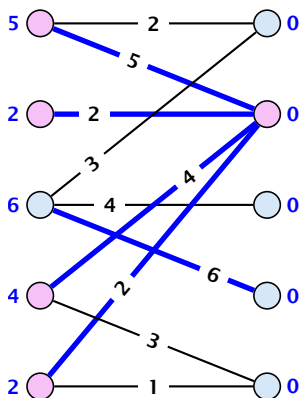

Weighted Bipartite Matching

Edges not drawn have weight 0.

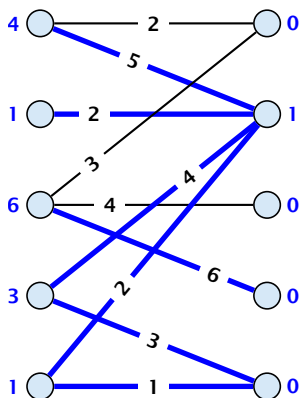

Weighted Bipartite Matching

Edges not drawn have weight 0.

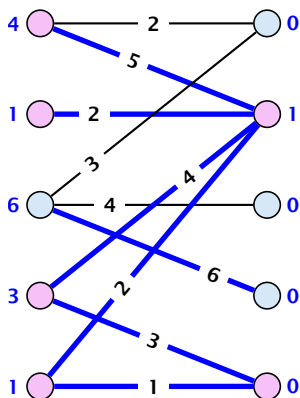

Weighted Bipartite Matching

Edges not drawn have weight 0.

$$\delta = 1$$

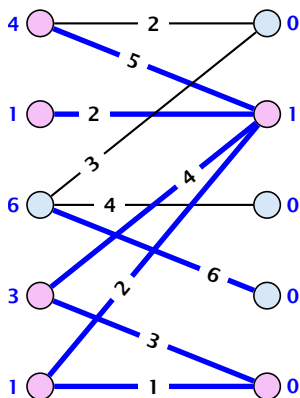

Weighted Bipartite Matching

Edges not drawn have weight 0.

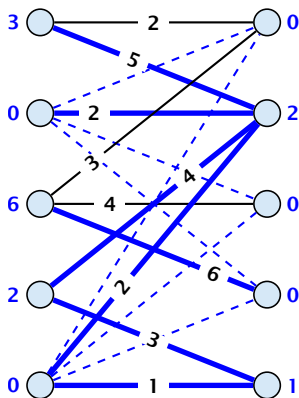

Weighted Bipartite Matching

Edges not drawn have weight 0.

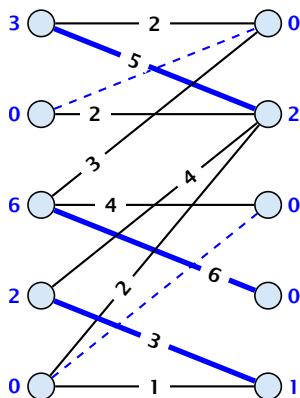

Weighted Bipartite Matching

Edges not drawn have weight 0.

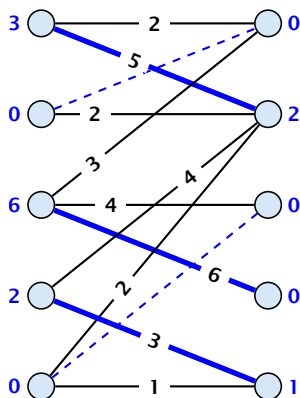

How many iterations do we need?

- ▶ One reweighting step increases the number of edges out of S by at least one.
- ▶ Assume that we have a maximum matching that saturates the set $\Gamma(S)$, in the sense that every node in $\Gamma(S)$ is matched to a node in S (we will show that we can always find S and a matching such that this holds).
- ▶ This matching is still contained in the new graph, because all its edges either go between $\Gamma(S)$ and S or between $L - S$ and $R - \Gamma(S)$.
- ▶ Hence, reweighting does not decrease the size of a maximum matching in the tight sub-graph.

How many iterations do we need?

- ▶ One reweighting step increases the number of edges out of S by at least one.
- ▶ Assume that we have a maximum matching that saturates the set $\Gamma(S)$, in the sense that every node in $\Gamma(S)$ is matched to a node in S (we will show that we can always find S and a matching such that this holds).
- ▶ This matching is still contained in the new graph, because all its edges either go between $\Gamma(S)$ and S or between $L - S$ and $R - \Gamma(S)$.
- ▶ Hence, reweighting does not decrease the size of a maximum matching in the tight sub-graph.

How many iterations do we need?

- ▶ One reweighting step increases the number of edges out of S by at least one.
- ▶ Assume that we have a maximum matching that saturates the set $\Gamma(S)$, in the sense that every node in $\Gamma(S)$ is matched to a node in S (we will show that we can always find S and a matching such that this holds).
- ▶ This matching is still contained in the new graph, because all its edges either go between $\Gamma(S)$ and S or between $L - S$ and $R - \Gamma(S)$.
- ▶ Hence, reweighting does not decrease the size of a maximum matching in the tight sub-graph.

How many iterations do we need?

- ▶ One reweighting step increases the number of edges out of S by at least one.
- ▶ Assume that we have a maximum matching that saturates the set $\Gamma(S)$, in the sense that every node in $\Gamma(S)$ is matched to a node in S (we will show that we can always find S and a matching such that this holds).
- ▶ This matching is still contained in the new graph, because all its edges either go between $\Gamma(S)$ and S or between $L - S$ and $R - \Gamma(S)$.
- ▶ Hence, reweighting does not decrease the size of a maximum matching in the tight sub-graph.

Analysis

- ▶ We will show that after at most n reweighting steps the size of the maximum matching can be increased by finding an augmenting path.
- ▶ This gives a polynomial running time.

How to find an augmenting path?

Construct an alternating tree.

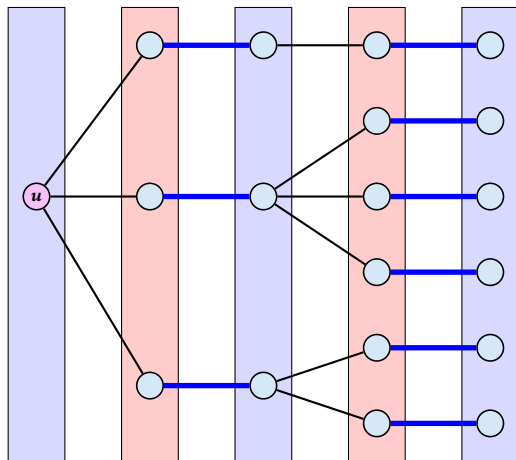

How to find an augmenting path?

Construct an alternating tree.

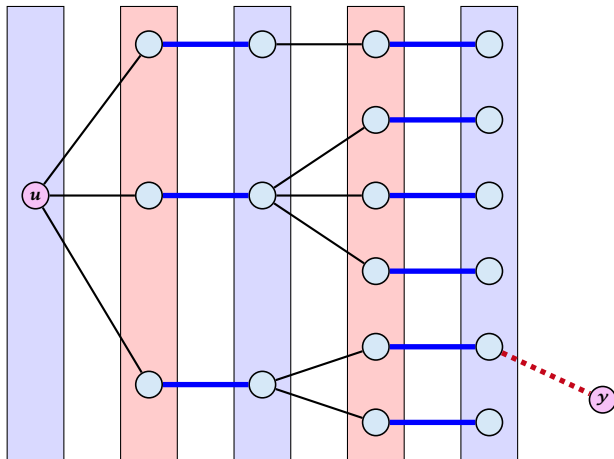

How do we find S ?

- ▶ Start on the left and compute an alternating tree, starting at any free node u .
- ▶ If this construction stops, there is no perfect matching in the tight subgraph (because for a perfect matching we need to find an augmenting path starting at u).
- ▶ The set of even vertices is on the left and the set of odd vertices is on the right and contains all neighbours of even nodes.
- ▶ All odd vertices are matched to even vertices. Furthermore, the even vertices additionally contain the free vertex u . Hence, $|V_{\text{odd}}| = |\Gamma(V_{\text{even}})| < |V_{\text{even}}|$, and all odd vertices are saturated in the current matching.

How do we find S ?

- ▶ Start on the left and compute an alternating tree, starting at any free node u .
- ▶ If this construction stops, there is no perfect matching in the tight subgraph (because for a perfect matching we need to find an augmenting path starting at u).
- ▶ The set of even vertices is on the left and the set of odd vertices is on the right and contains all neighbours of even nodes.
- ▶ All odd vertices are matched to even vertices. Furthermore, the even vertices additionally contain the free vertex u . Hence, $|V_{\text{odd}}| = |\Gamma(V_{\text{even}})| < |V_{\text{even}}|$, and all odd vertices are saturated in the current matching.

How do we find S ?

- ▶ Start on the left and compute an alternating tree, starting at any free node u .
- ▶ If this construction stops, there is no perfect matching in the tight subgraph (because for a perfect matching we need to find an augmenting path starting at u).
- ▶ The set of even vertices is on the left and the set of odd vertices is on the right **and** contains all neighbours of even nodes.
- ▶ All odd vertices are matched to even vertices. Furthermore, the even vertices additionally contain the free vertex u . Hence, $|V_{\text{odd}}| = |\Gamma(V_{\text{even}})| < |V_{\text{even}}|$, and all odd vertices are saturated in the current matching.

Analysis

How do we find S ?

- ▶ Start on the left and compute an alternating tree, starting at any free node u .
- ▶ If this construction stops, there is no perfect matching in the tight subgraph (because for a perfect matching we need to find an augmenting path starting at u).
- ▶ The set of even vertices is on the left and the set of odd vertices is on the right **and** contains all neighbours of even nodes.
- ▶ All odd vertices are matched to even vertices. Furthermore, the even vertices additionally contain the free vertex u . Hence, $|V_{\text{odd}}| = |\Gamma(V_{\text{even}})| < |V_{\text{even}}|$, and all odd vertices are saturated in the current matching.

Analysis

- ▶ The current matching does not have any edges from V_{odd} to outside of $L \setminus V_{\text{even}}$ (edges that may possibly be deleted by changing weights).
- ▶ After changing weights, there is at least one more edge connecting V_{even} to a node outside of V_{odd} . After at most n reweightings we can do an augmentation.
- ▶ A reweighting can be trivially performed in time $\mathcal{O}(n^2)$ (keeping track of the tight edges).
- ▶ An augmentation takes at most $\mathcal{O}(n)$ time.
- ▶ In total we obtain a running time of $\mathcal{O}(n^4)$.
- ▶ A more careful implementation of the algorithm obtains a running time of $\mathcal{O}(n^3)$.

Analysis

- ▶ The current matching does not have any edges from V_{odd} to outside of $L \setminus V_{\text{even}}$ (edges that may possibly be deleted by changing weights).
- ▶ After changing weights, there is at least one more edge connecting V_{even} to a node outside of V_{odd} . After at most n reweightings we can do an augmentation.
- ▶ A reweighting can be trivially performed in time $\mathcal{O}(n^2)$ (keeping track of the tight edges).
- ▶ An augmentation takes at most $\mathcal{O}(n)$ time.
- ▶ In total we obtain a running time of $\mathcal{O}(n^4)$.
- ▶ A more careful implementation of the algorithm obtains a running time of $\mathcal{O}(n^3)$.

Analysis

- ▶ The current matching does not have any edges from V_{odd} to outside of $L \setminus V_{\text{even}}$ (edges that may possibly be deleted by changing weights).
- ▶ After changing weights, there is at least one more edge connecting V_{even} to a node outside of V_{odd} . After at most n reweightings we can do an augmentation.
- ▶ A reweighting can be trivially performed in time $\mathcal{O}(n^2)$ (keeping track of the tight edges).
 - ▶ An augmentation takes at most $\mathcal{O}(n)$ time.
 - ▶ In total we obtain a running time of $\mathcal{O}(n^4)$.
 - ▶ A more careful implementation of the algorithm obtains a running time of $\mathcal{O}(n^3)$.

Analysis

- ▶ The current matching does not have any edges from V_{odd} to outside of $L \setminus V_{\text{even}}$ (edges that may possibly be deleted by changing weights).
- ▶ After changing weights, there is at least one more edge connecting V_{even} to a node outside of V_{odd} . After at most n reweightings we can do an augmentation.
- ▶ A reweighting can be trivially performed in time $\mathcal{O}(n^2)$ (keeping track of the tight edges).
- ▶ An augmentation takes at most $\mathcal{O}(n)$ time.
 - ▶ In total we obtain a running time of $\mathcal{O}(n^4)$.
 - ▶ A more careful implementation of the algorithm obtains a running time of $\mathcal{O}(n^3)$.

Analysis

- ▶ The current matching does not have any edges from V_{odd} to outside of $L \setminus V_{\text{even}}$ (edges that may possibly be deleted by changing weights).
- ▶ After changing weights, there is at least one more edge connecting V_{even} to a node outside of V_{odd} . After at most n reweightings we can do an augmentation.
- ▶ A reweighting can be trivially performed in time $\mathcal{O}(n^2)$ (keeping track of the tight edges).
- ▶ An augmentation takes at most $\mathcal{O}(n)$ time.
- ▶ In total we obtain a running time of $\mathcal{O}(n^4)$.
- ▶ A more careful implementation of the algorithm obtains a running time of $\mathcal{O}(n^3)$.

Analysis

- ▶ The current matching does not have any edges from V_{odd} to outside of $L \setminus V_{\text{even}}$ (edges that may possibly be deleted by changing weights).
- ▶ After changing weights, there is at least one more edge connecting V_{even} to a node outside of V_{odd} . After at most n reweightings we can do an augmentation.
- ▶ A reweighting can be trivially performed in time $\mathcal{O}(n^2)$ (keeping track of the tight edges).
- ▶ An augmentation takes at most $\mathcal{O}(n)$ time.
- ▶ In total we obtain a running time of $\mathcal{O}(n^4)$.
- ▶ A more careful implementation of the algorithm obtains a running time of $\mathcal{O}(n^3)$.