

18 Augmenting Paths for Matchings

Definitions.

- ▶ Given a matching M in a graph G , a vertex that is not incident to any edge of M is called a **free vertex** w. r. .t. M .
- ▶ For a matching M a path P in G is called an **alternating path** if edges in M alternate with edges not in M .
- ▶ An alternating path is called an **augmenting path** for matching M if it ends at distinct free vertices.

Theorem 1

A matching M is a maximum matching if and only if there is no augmenting path w. r. t. M .

18 Augmenting Paths for Matchings

Definitions.

- ▶ Given a matching M in a graph G , a vertex that is not incident to any edge of M is called a **free vertex** w. r. .t. M .
- ▶ For a matching M a path P in G is called an **alternating path** if edges in M alternate with edges not in M .
- ▶ An alternating path is called an **augmenting path** for matching M if it ends at distinct free vertices.

Theorem 1

A matching M is a maximum matching if and only if there is no augmenting path w. r. t. M .

18 Augmenting Paths for Matchings

Definitions.

- ▶ Given a matching M in a graph G , a vertex that is not incident to any edge of M is called a **free vertex** w. r. .t. M .
- ▶ For a matching M a path P in G is called an **alternating path** if edges in M alternate with edges not in M .
- ▶ An alternating path is called an **augmenting path** for matching M if it ends at distinct free vertices.

Theorem 1

A matching M is a maximum matching if and only if there is no augmenting path w. r. t. M .

18 Augmenting Paths for Matchings

Definitions.

- ▶ Given a matching M in a graph G , a vertex that is not incident to any edge of M is called a **free vertex** w. r. .t. M .
- ▶ For a matching M a path P in G is called an **alternating path** if edges in M alternate with edges not in M .
- ▶ An alternating path is called an **augmenting path** for matching M if it ends at distinct free vertices.

Theorem 1

A matching M is a maximum matching if and only if there is no augmenting path w. r. t. M .

Augmenting Paths in Action

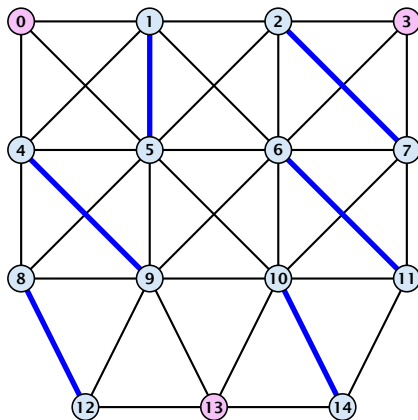

Augmenting Paths in Action

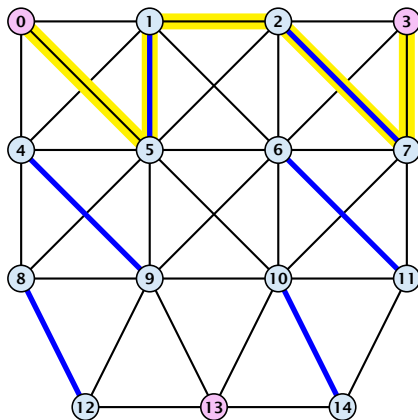

Augmenting Paths in Action

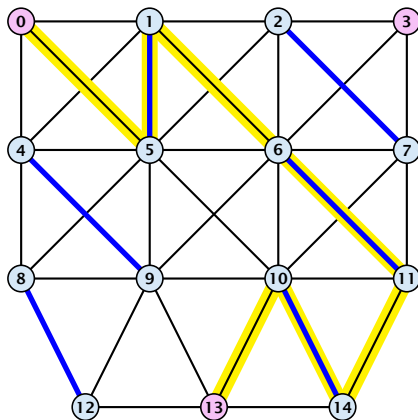

Augmenting Paths in Action

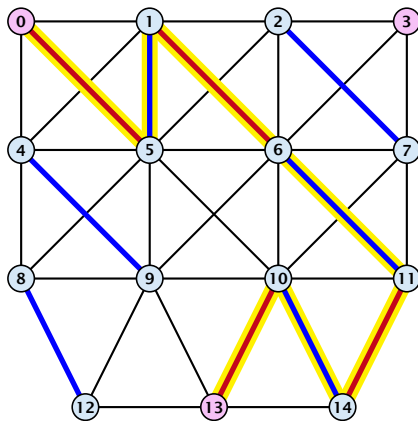

Augmenting Paths in Action

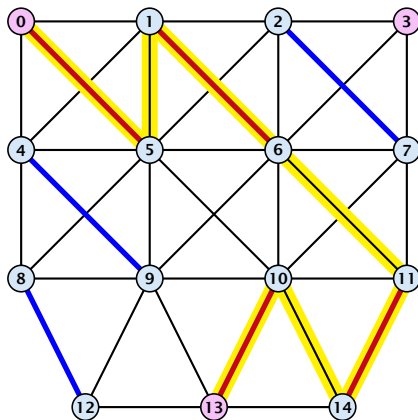

Augmenting Paths in Action

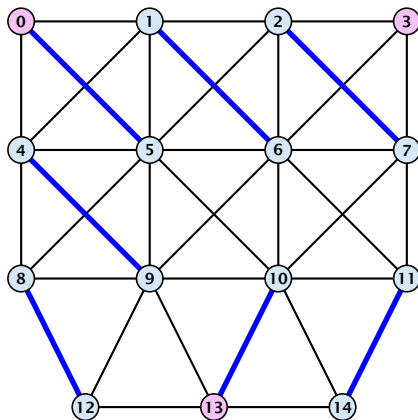

18 Augmenting Paths for Matchings

Proof.

- ⇒ If M is maximum there is no augmenting path P , because we could switch matching and non-matching edges along P . This gives matching $M' = M \oplus P$ with larger cardinality.
- ⇐ Suppose there is a matching M' with larger cardinality. Consider the graph H with edge-set $M' \oplus M$ (i.e., only edges that are in either M or M' but not in both).

Each vertex can be incident to at most two edges (one from M and one from M'). Hence, the connected components are alternating cycles or alternating path.

As $|M'| > |M|$ there is one connected component that is a path P for which both endpoints are incident to edges from M' . P is an augmenting path.

18 Augmenting Paths for Matchings

Proof.

- ⇒ If M is maximum there is no augmenting path P , because we could switch matching and non-matching edges along P . This gives matching $M' = M \oplus P$ with larger cardinality.
- ⇐ Suppose there is a matching M' with larger cardinality. Consider the graph H with edge-set $M' \oplus M$ (i.e., only edges that are in either M or M' but not in both).

Each vertex can be incident to at most two edges (one from M and one from M'). Hence, the connected components are alternating cycles or alternating path.

As $|M'| > |M|$ there is one connected component that is a path P for which both endpoints are incident to edges from M' . P is an augmenting path.

18 Augmenting Paths for Matchings

Proof.

- ⇒ If M is maximum there is no augmenting path P , because we could switch matching and non-matching edges along P . This gives matching $M' = M \oplus P$ with larger cardinality.
- ⇐ Suppose there is a matching M' with larger cardinality. Consider the graph H with edge-set $M' \oplus M$ (i.e., only edges that are in either M or M' but not in both).

Each vertex can be incident to at most two edges (one from M and one from M'). Hence, the connected components are alternating cycles or alternating path.

As $|M'| > |M|$ there is one connected component that is a path P for which both endpoints are incident to edges from M' . P is an augmenting path.

18 Augmenting Paths for Matchings

Proof.

- ⇒ If M is maximum there is no augmenting path P , because we could switch matching and non-matching edges along P . This gives matching $M' = M \oplus P$ with larger cardinality.
- ⇐ Suppose there is a matching M' with larger cardinality. Consider the graph H with edge-set $M' \oplus M$ (i.e., only edges that are in either M or M' but not in both).

Each vertex can be incident to at most two edges (one from M and one from M'). Hence, the connected components are alternating cycles or alternating path.

As $|M'| > |M|$ there is one connected component that is a path P for which both endpoints are incident to edges from M' . P is an augmenting path.

18 Augmenting Paths for Matchings

Algorithmic idea:

As long as you find an augmenting path augment your matching using this path. When you arrive at a matching for which no augmenting path exists you have a maximum matching.

Theorem 2

Let G be a graph, M a matching in G , and let u be a free vertex w.r.t. M . Further let P denote an augmenting path w.r.t. M and let $M' = M \oplus P$ denote the matching resulting from augmenting M with P . If there was no augmenting path starting at u in M then there is no augmenting path starting at u in M' .

18 Augmenting Paths for Matchings

Algorithmic idea:

As long as you find an augmenting path augment your matching using this path. When you arrive at a matching for which no augmenting path exists you have a maximum matching.

Theorem 2

Let G be a graph, M a matching in G , and let u be a free vertex w.r.t. M . Further let P denote an augmenting path w.r.t. M and let $M' = M \oplus P$ denote the matching resulting from augmenting M with P . If there was no augmenting path starting at u in M then there is no augmenting path starting at u in M' .

18 Augmenting Paths for Matchings

Proof

18 Augmenting Paths for Matchings

Proof

- ▶ Assume there is an augmenting path P' w.r.t. M' starting at u .

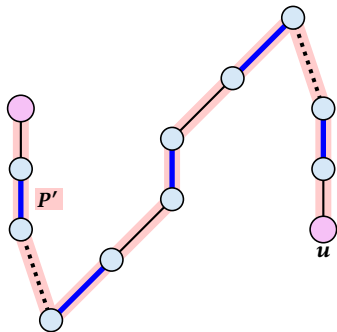

18 Augmenting Paths for Matchings

Proof

- ▶ Assume there is an augmenting path P' w.r.t. M' starting at u .
- ▶ If P' and P are node-disjoint, P' is also augmenting path w.r.t. M (ℓ).

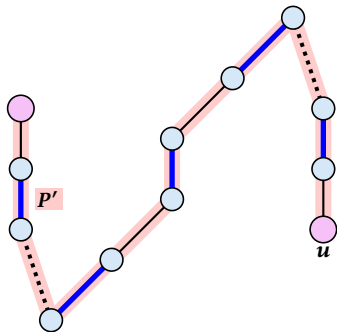

18 Augmenting Paths for Matchings

Proof

- ▶ Assume there is an augmenting path P' w.r.t. M' starting at u .
- ▶ If P' and P are node-disjoint, P' is also augmenting path w.r.t. M (\neq).

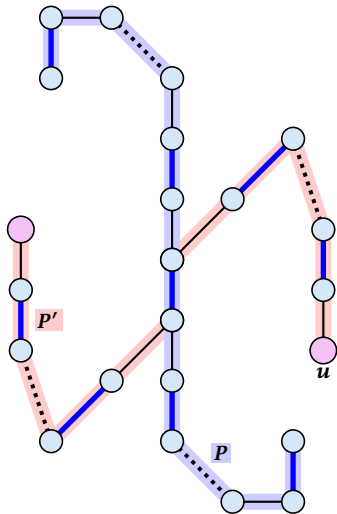

18 Augmenting Paths for Matchings

Proof

- ▶ Assume there is an augmenting path P' w.r.t. M' starting at u .
- ▶ If P' and P are node-disjoint, P' is also augmenting path w.r.t. M (\neq).
- ▶ Let u' be the **first** node on P' that is in P , and let e be the matching edge from M' incident to u' .

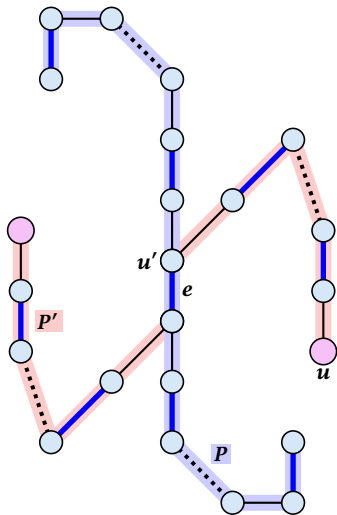

18 Augmenting Paths for Matchings

Proof

- ▶ Assume there is an augmenting path P' w.r.t. M' starting at u .
- ▶ If P' and P are node-disjoint, P' is also augmenting path w.r.t. M (\neq).
- ▶ Let u' be the **first** node on P' that is in P , and let e be the matching edge from M' incident to u' .

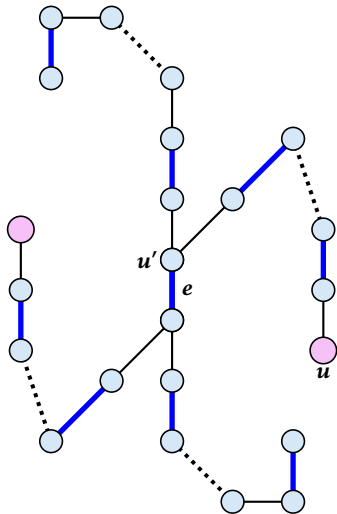

18 Augmenting Paths for Matchings

Proof

- ▶ Assume there is an augmenting path P' w.r.t. M' starting at u .
- ▶ If P' and P are node-disjoint, P' is also augmenting path w.r.t. M (ℓ).
- ▶ Let u' be the **first** node on P' that is in P , and let e be the matching edge from M' incident to u' .

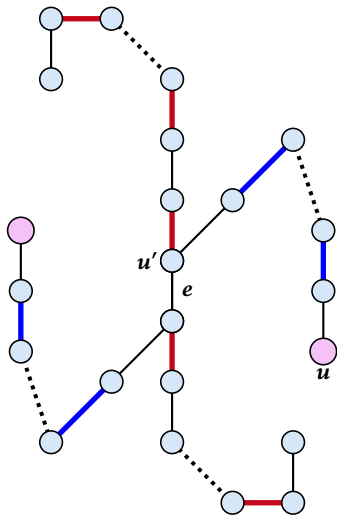

18 Augmenting Paths for Matchings

Proof

- ▶ Assume there is an augmenting path P' w.r.t. M' starting at u .
- ▶ If P' and P are node-disjoint, P' is also augmenting path w.r.t. M (ℓ).
- ▶ Let u' be the **first** node on P' that is in P , and let e be the matching edge from M' incident to u' .
- ▶ u' splits P into two parts one of which does not contain e . Call this part P_1 . Denote the sub-path of P' from u to u' with P'_1 .

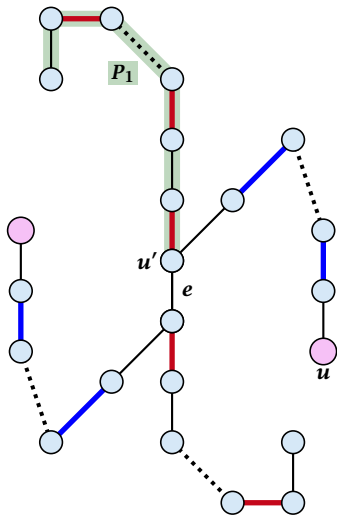

18 Augmenting Paths for Matchings

Proof

- ▶ Assume there is an augmenting path P' w.r.t. M' starting at u .
- ▶ If P' and P are node-disjoint, P' is also augmenting path w.r.t. M (ℓ).
- ▶ Let u' be the **first** node on P' that is in P , and let e be the matching edge from M' incident to u' .
- ▶ u' splits P into two parts one of which does not contain e . Call this part P_1 . Denote the sub-path of P' from u to u' with P'_1 .

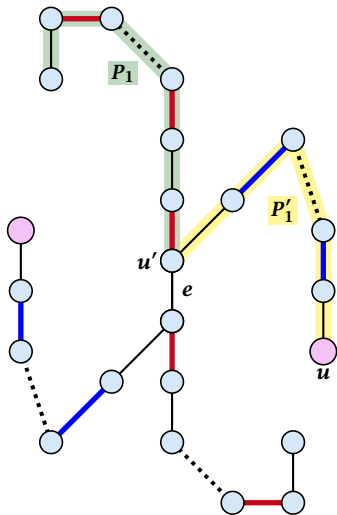

18 Augmenting Paths for Matchings

Proof

- ▶ Assume there is an augmenting path P' w.r.t. M' starting at u .
- ▶ If P' and P are node-disjoint, P' is also augmenting path w.r.t. M (\cancel{f}).
- ▶ Let u' be the **first** node on P' that is in P , and let e be the matching edge from M' incident to u' .
- ▶ u' splits P into two parts one of which does not contain e . Call this part P_1 . Denote the sub-path of P' from u to u' with P'_1 .
- ▶ $P_1 \circ P'_1$ is augmenting path in M (\cancel{f}).

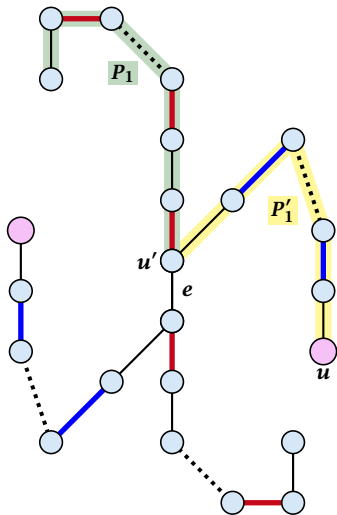

How to find an augmenting path?

Construct an alternating tree.

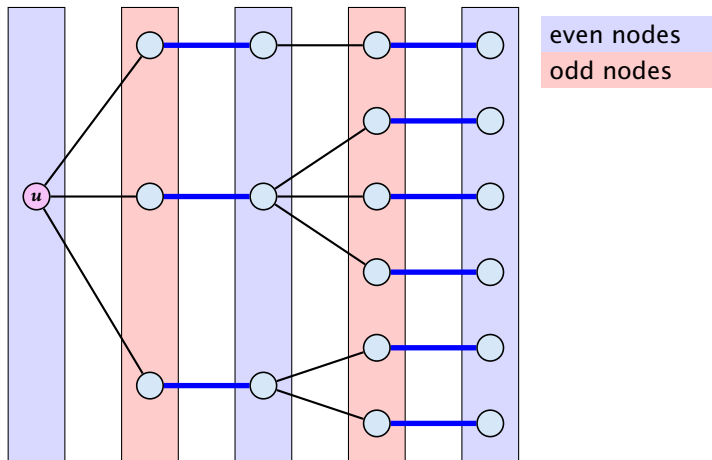

How to find an augmenting path?

Construct an alternating tree.

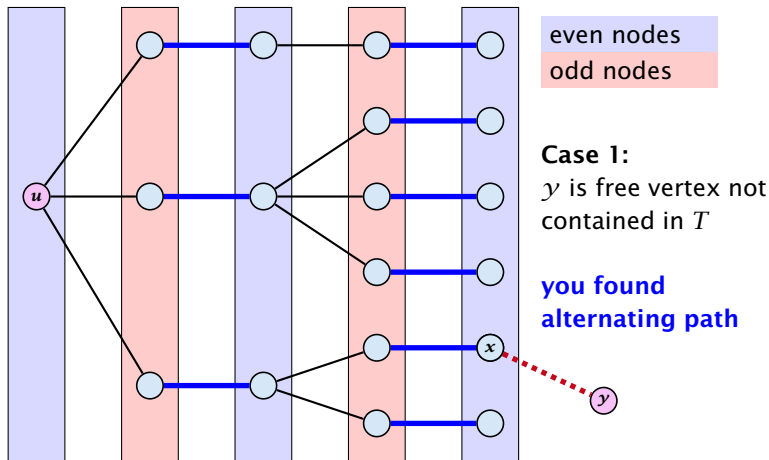

How to find an augmenting path?

Construct an alternating tree.

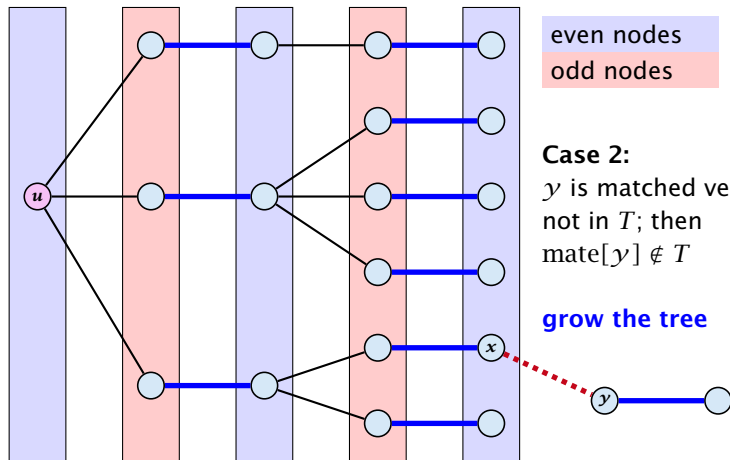

How to find an augmenting path?

Construct an alternating tree.

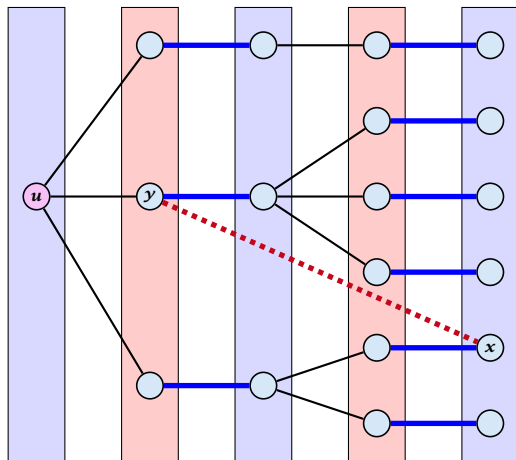

even nodes

odd nodes

Case 3:

y is already contained
in T as an odd vertex

ignore successor y

How to find an augmenting path?

Construct an alternating tree.

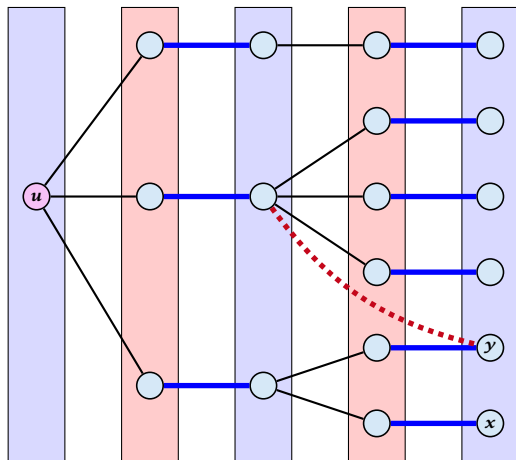

even nodes

odd nodes

Case 4:

y is already contained
in T as an even vertex

can't ignore y

does not happen in
bipartite graphs

Algorithm 50 BiMatch($G, match$)

```
1: for  $x \in V$  do  $mate[x] \leftarrow 0$ ;  
2:  $r \leftarrow 0$ ;  $free \leftarrow n$ ;  
3: while  $free \geq 1$  and  $r < n$  do  
4:    $r \leftarrow r + 1$   
5:   if  $mate[r] = 0$  then  
6:     for  $i = 1$  to  $m$  do  $parent[i'] \leftarrow 0$   
7:      $Q \leftarrow \emptyset$ ;  $Q.append(r)$ ;  $aug \leftarrow false$ ;  
8:     while  $aug = false$  and  $Q \neq \emptyset$  do  
9:        $x \leftarrow Q.dequeue()$ ;  
10:      for  $y \in A_x$  do  
11:        if  $mate[y] = 0$  then  
12:           $augm(mate, parent, y)$ ;  
13:           $aug \leftarrow true$ ;  
14:           $free \leftarrow free - 1$ ;  
15:        else  
16:          if  $parent[y] = 0$  then  
17:             $parent[y] \leftarrow x$ ;  
18:             $Q.enqueue(mate[y])$ ;
```

graph $G = (S \cup S', E)$

$S = \{1, \dots, n\}$

$S' = \{1', \dots, n'\}$

Algorithm 50 BiMatch($G, match$)

```
1: for  $x \in V$  do  $mate[x] \leftarrow 0$ ;  
2:  $r \leftarrow 0$ ;  $free \leftarrow n$ ;  
3: while  $free \geq 1$  and  $r < n$  do  
4:    $r \leftarrow r + 1$   
5:   if  $mate[r] = 0$  then  
6:     for  $i = 1$  to  $m$  do  $parent[i'] \leftarrow 0$   
7:      $Q \leftarrow \emptyset$ ;  $Q.append(r)$ ;  $aug \leftarrow false$ ;  
8:     while  $aug = false$  and  $Q \neq \emptyset$  do  
9:        $x \leftarrow Q.dequeue()$ ;  
10:      for  $y \in A_x$  do  
11:        if  $mate[y] = 0$  then  
12:           $augm(mate, parent, y)$ ;  
13:           $aug \leftarrow true$ ;  
14:           $free \leftarrow free - 1$ ;  
15:        else  
16:          if  $parent[y] = 0$  then  
17:             $parent[y] \leftarrow x$ ;  
18:             $Q.enqueue(mate[y])$ ;
```

start with an
empty matching

Algorithm 50 BiMatch($G, match$)

```
1: for  $x \in V$  do  $mate[x] \leftarrow 0$ ;  
2:  $r \leftarrow 0$ ;  $free \leftarrow n$ ;  
3: while  $free \geq 1$  and  $r < n$  do  
4:    $r \leftarrow r + 1$   
5:   if  $mate[r] = 0$  then  
6:     for  $i = 1$  to  $m$  do  $parent[i'] \leftarrow 0$   
7:      $Q \leftarrow \emptyset$ ;  $Q.append(r)$ ;  $aug \leftarrow false$ ;  
8:     while  $aug = false$  and  $Q \neq \emptyset$  do  
9:        $x \leftarrow Q.dequeue()$ ;  
10:      for  $y \in A_x$  do  
11:        if  $mate[y] = 0$  then  
12:           $augm(mate, parent, y)$ ;  
13:           $aug \leftarrow true$ ;  
14:           $free \leftarrow free - 1$ ;  
15:        else  
16:          if  $parent[y] = 0$  then  
17:             $parent[y] \leftarrow x$ ;  
18:             $Q.enqueue(mate[y])$ ;
```

free: number of
unmatched nodes in
 S

r: root of current tree

Algorithm 50 BiMatch($G, match$)

```
1: for  $x \in V$  do  $mate[x] \leftarrow 0$ ;  
2:  $r \leftarrow 0$ ;  $free \leftarrow n$ ;  
3: while  $free \geq 1$  and  $r < n$  do  
4:    $r \leftarrow r + 1$   
5:   if  $mate[r] = 0$  then  
6:     for  $i = 1$  to  $m$  do  $parent[i'] \leftarrow 0$   
7:      $Q \leftarrow \emptyset$ ;  $Q.append(r)$ ;  $aug \leftarrow false$ ;  
8:     while  $aug = false$  and  $Q \neq \emptyset$  do  
9:        $x \leftarrow Q.dequeue()$ ;  
10:      for  $y \in A_x$  do  
11:        if  $mate[y] = 0$  then  
12:           $augm(mate, parent, y)$ ;  
13:           $aug \leftarrow true$ ;  
14:           $free \leftarrow free - 1$ ;  
15:        else  
16:          if  $parent[y] = 0$  then  
17:             $parent[y] \leftarrow x$ ;  
18:             $Q.enqueue(mate[y])$ ;
```

as long as there are
unmatched nodes and
we did not yet try to
grow from all nodes we
continue

Algorithm 50 BiMatch($G, match$)

```
1: for  $x \in V$  do  $mate[x] \leftarrow 0$ ;  
2:  $r \leftarrow 0$ ;  $free \leftarrow n$ ;  
3: while  $free \geq 1$  and  $r < n$  do  
4:    $r \leftarrow r + 1$   
5:   if  $mate[r] = 0$  then  
6:     for  $i = 1$  to  $m$  do  $parent[i'] \leftarrow 0$   
7:      $Q \leftarrow \emptyset$ ;  $Q.append(r)$ ;  $aug \leftarrow false$ ;  
8:     while  $aug = false$  and  $Q \neq \emptyset$  do  
9:        $x \leftarrow Q.dequeue()$ ;  
10:      for  $y \in A_x$  do  
11:        if  $mate[y] = 0$  then  
12:           $augm(mate, parent, y)$ ;  
13:           $aug \leftarrow true$ ;  
14:           $free \leftarrow free - 1$ ;  
15:        else  
16:          if  $parent[y] = 0$  then  
17:             $parent[y] \leftarrow x$ ;  
18:             $Q.enqueue(mate[y])$ ;
```

r is the new node that we grow from.

Algorithm 50 BiMatch($G, match$)

```
1: for  $x \in V$  do  $mate[x] \leftarrow 0$ ;  
2:  $r \leftarrow 0$ ;  $free \leftarrow n$ ;  
3: while  $free \geq 1$  and  $r < n$  do  
4:    $r \leftarrow r + 1$   
5:   if  $mate[r] = 0$  then  
6:     for  $i = 1$  to  $m$  do  $parent[i'] \leftarrow 0$   
7:      $Q \leftarrow \emptyset$ ;  $Q.append(r)$ ;  $aug \leftarrow false$ ;  
8:     while  $aug = false$  and  $Q \neq \emptyset$  do  
9:        $x \leftarrow Q.dequeue()$ ;  
10:      for  $y \in A_x$  do  
11:        if  $mate[y] = 0$  then  
12:           $augm(mate, parent, y)$ ;  
13:           $aug \leftarrow true$ ;  
14:           $free \leftarrow free - 1$ ;  
15:        else  
16:          if  $parent[y] = 0$  then  
17:             $parent[y] \leftarrow x$ ;  
18:             $Q.enqueue(mate[y])$ ;
```

If r is free start tree construction

Algorithm 50 BiMatch($G, match$)

```
1: for  $x \in V$  do  $mate[x] \leftarrow 0$ ;  
2:  $r \leftarrow 0$ ;  $free \leftarrow n$ ;  
3: while  $free \geq 1$  and  $r < n$  do  
4:    $r \leftarrow r + 1$   
5:   if  $mate[r] = 0$  then  
6:     for  $i = 1$  to  $m$  do  $parent[i'] \leftarrow 0$   
7:      $Q \leftarrow \emptyset$ ;  $Q.append(r)$ ;  $aug \leftarrow false$ ;  
8:     while  $aug = false$  and  $Q \neq \emptyset$  do  
9:        $x \leftarrow Q.dequeue()$ ;  
10:      for  $y \in A_x$  do  
11:        if  $mate[y] = 0$  then  
12:           $augm(mate, parent, y)$ ;  
13:           $aug \leftarrow true$ ;  
14:           $free \leftarrow free - 1$ ;  
15:        else  
16:          if  $parent[y] = 0$  then  
17:             $parent[y] \leftarrow x$ ;  
18:             $Q.enqueue(mate[y])$ ;
```

Initialize an empty tree.
Note that only nodes i'
have parent pointers.

Algorithm 50 BiMatch($G, match$)

```
1: for  $x \in V$  do  $mate[x] \leftarrow 0$ ;  
2:  $r \leftarrow 0$ ;  $free \leftarrow n$ ;  
3: while  $free \geq 1$  and  $r < n$  do  
4:    $r \leftarrow r + 1$   
5:   if  $mate[r] = 0$  then  
6:     for  $i = 1$  to  $m$  do  $parent[i'] \leftarrow 0$   
7:      $Q \leftarrow \emptyset$ ;  $Q.append(r)$ ;  $aug \leftarrow false$ ;  
8:     while  $aug = false$  and  $Q \neq \emptyset$  do  
9:        $x \leftarrow Q.dequeue()$ ;  
10:      for  $y \in A_x$  do  
11:        if  $mate[y] = 0$  then  
12:           $augm(mate, parent, y)$ ;  
13:           $aug \leftarrow true$ ;  
14:           $free \leftarrow free - 1$ ;  
15:        else  
16:          if  $parent[y] = 0$  then  
17:             $parent[y] \leftarrow x$ ;  
18:             $Q.enqueue(mate[y])$ ;
```

Q is a queue (BFS!!!).

aug is a Boolean that stores whether we already found an augmenting path.

Algorithm 50 BiMatch($G, match$)

```
1: for  $x \in V$  do  $mate[x] \leftarrow 0$ ;  
2:  $r \leftarrow 0$ ;  $free \leftarrow n$ ;  
3: while  $free \geq 1$  and  $r < n$  do  
4:    $r \leftarrow r + 1$   
5:   if  $mate[r] = 0$  then  
6:     for  $i = 1$  to  $m$  do  $parent[i'] \leftarrow 0$   
7:      $Q \leftarrow \emptyset$ ;  $Q.append(r)$ ;  $aug \leftarrow false$ ;  
8:     while  $aug = false$  and  $Q \neq \emptyset$  do  
9:        $x \leftarrow Q.dequeue()$ ;  
10:      for  $y \in A_x$  do  
11:        if  $mate[y] = 0$  then  
12:           $augm(mate, parent, y)$ ;  
13:           $aug \leftarrow true$ ;  
14:           $free \leftarrow free - 1$ ;  
15:        else  
16:          if  $parent[y] = 0$  then  
17:             $parent[y] \leftarrow x$ ;  
18:             $Q.enqueue(mate[y])$ ;
```

as long as we did not augment and there are still unexamined leaves continue...

Algorithm 50 BiMatch($G, match$)

```
1: for  $x \in V$  do  $mate[x] \leftarrow 0$ ;  
2:  $r \leftarrow 0$ ;  $free \leftarrow n$ ;  
3: while  $free \geq 1$  and  $r < n$  do  
4:    $r \leftarrow r + 1$   
5:   if  $mate[r] = 0$  then  
6:     for  $i = 1$  to  $m$  do  $parent[i'] \leftarrow 0$   
7:      $Q \leftarrow \emptyset$ ;  $Q.append(r)$ ;  $aug \leftarrow false$ ;  
8:     while  $aug = false$  and  $Q \neq \emptyset$  do  
9:        $x \leftarrow Q.dequeue()$ ;  
10:      for  $y \in A_x$  do  
11:        if  $mate[y] = 0$  then  
12:           $augm(mate, parent, y)$ ;  
13:           $aug \leftarrow true$ ;  
14:           $free \leftarrow free - 1$ ;  
15:        else  
16:          if  $parent[y] = 0$  then  
17:             $parent[y] \leftarrow x$ ;  
18:             $Q.enqueue(mate[y])$ ;
```

take next unexamined
leaf

Algorithm 50 BiMatch($G, match$)

```
1: for  $x \in V$  do  $mate[x] \leftarrow 0$ ;  
2:  $r \leftarrow 0$ ;  $free \leftarrow n$ ;  
3: while  $free \geq 1$  and  $r < n$  do  
4:    $r \leftarrow r + 1$   
5:   if  $mate[r] = 0$  then  
6:     for  $i = 1$  to  $m$  do  $parent[i'] \leftarrow 0$   
7:      $Q \leftarrow \emptyset$ ;  $Q.append(r)$ ;  $aug \leftarrow false$ ;  
8:     while  $aug = false$  and  $Q \neq \emptyset$  do  
9:        $x \leftarrow Q.dequeue()$ ;  
10:      for  $y \in A_x$  do  
11:        if  $mate[y] = 0$  then  
12:           $augm(mate, parent, y)$ ;  
13:           $aug \leftarrow true$ ;  
14:           $free \leftarrow free - 1$ ;  
15:        else  
16:          if  $parent[y] = 0$  then  
17:             $parent[y] \leftarrow x$ ;  
18:             $Q.enqueue(mate[y])$ ;
```

if x has unmatched neighbour we found an augmenting path (note that $y \neq r$ because we are in a bipartite graph)

Algorithm 50 BiMatch($G, match$)

```
1: for  $x \in V$  do  $mate[x] \leftarrow 0$ ;  
2:  $r \leftarrow 0$ ;  $free \leftarrow n$ ;  
3: while  $free \geq 1$  and  $r < n$  do  
4:    $r \leftarrow r + 1$   
5:   if  $mate[r] = 0$  then  
6:     for  $i = 1$  to  $m$  do  $parent[i'] \leftarrow 0$   
7:      $Q \leftarrow \emptyset$ ;  $Q.append(r)$ ;  $aug \leftarrow false$ ;  
8:     while  $aug = false$  and  $Q \neq \emptyset$  do  
9:        $x \leftarrow Q.dequeue()$ ;  
10:      for  $y \in A_x$  do  
11:        if  $mate[y] = 0$  then  
12:           $augm(mate, parent, y)$ ;  
13:           $aug \leftarrow true$ ;  
14:           $free \leftarrow free - 1$ ;  
15:        else  
16:          if  $parent[y] = 0$  then  
17:             $parent[y] \leftarrow x$ ;  
18:             $Q.enqueue(mate[y])$ ;
```

do an augmentation...

Algorithm 50 BiMatch($G, match$)

```
1: for  $x \in V$  do  $mate[x] \leftarrow 0$ ;  
2:  $r \leftarrow 0$ ;  $free \leftarrow n$ ;  
3: while  $free \geq 1$  and  $r < n$  do  
4:    $r \leftarrow r + 1$   
5:   if  $mate[r] = 0$  then  
6:     for  $i = 1$  to  $m$  do  $parent[i'] \leftarrow 0$   
7:      $Q \leftarrow \emptyset$ ;  $Q.append(r)$ ;  $aug \leftarrow false$ ;  
8:     while  $aug = false$  and  $Q \neq \emptyset$  do  
9:        $x \leftarrow Q.dequeue()$ ;  
10:      for  $y \in A_x$  do  
11:        if  $mate[y] = 0$  then  
12:           $augm(mate, parent, y)$ ;  
13:           $aug \leftarrow true$ ;  
14:           $free \leftarrow free - 1$ ;  
15:      else  
16:        if  $parent[y] = 0$  then  
17:           $parent[y] \leftarrow x$ ;  
18:           $Q.enqueue(mate[y])$ ;
```

setting $aug = true$
ensures that the tree
construction will not
continue

Algorithm 50 BiMatch($G, match$)

```
1: for  $x \in V$  do  $mate[x] \leftarrow 0$ ;  
2:  $r \leftarrow 0$ ;  $free \leftarrow n$ ;  
3: while  $free \geq 1$  and  $r < n$  do  
4:    $r \leftarrow r + 1$   
5:   if  $mate[r] = 0$  then  
6:     for  $i = 1$  to  $m$  do  $parent[i'] \leftarrow 0$   
7:      $Q \leftarrow \emptyset$ ;  $Q.append(r)$ ;  $aug \leftarrow false$ ;  
8:     while  $aug = false$  and  $Q \neq \emptyset$  do  
9:        $x \leftarrow Q.dequeue()$ ;  
10:      for  $y \in A_x$  do  
11:        if  $mate[y] = 0$  then  
12:           $augm(mate, parent, y)$ ;  
13:           $aug \leftarrow true$ ;  
14:           $free \leftarrow free - 1$ ;  
15:        else  
16:          if  $parent[y] = 0$  then  
17:             $parent[y] \leftarrow x$ ;  
18:             $Q.enqueue(mate[y])$ ;
```

reduce number of free
nodes

Algorithm 50 BiMatch($G, match$)

```
1: for  $x \in V$  do  $mate[x] \leftarrow 0$ ;  
2:  $r \leftarrow 0$ ;  $free \leftarrow n$ ;  
3: while  $free \geq 1$  and  $r < n$  do  
4:    $r \leftarrow r + 1$   
5:   if  $mate[r] = 0$  then  
6:     for  $i = 1$  to  $m$  do  $parent[i'] \leftarrow 0$   
7:      $Q \leftarrow \emptyset$ ;  $Q.append(r)$ ;  $aug \leftarrow false$ ;  
8:     while  $aug = false$  and  $Q \neq \emptyset$  do  
9:        $x \leftarrow Q.dequeue()$ ;  
10:      for  $y \in A_x$  do  
11:        if  $mate[y] = 0$  then  
12:           $augm(mate, parent, y)$ ;  
13:           $aug \leftarrow true$ ;  
14:           $free \leftarrow free - 1$ ;  
15:        else  
16:          if  $parent[y] = 0$  then  
17:             $parent[y] \leftarrow x$ ;  
18:             $Q.enqueue(mate[y])$ ;
```

if y is not in the tree yet

Algorithm 50 BiMatch($G, match$)

```
1: for  $x \in V$  do  $mate[x] \leftarrow 0$ ;  
2:  $r \leftarrow 0$ ;  $free \leftarrow n$ ;  
3: while  $free \geq 1$  and  $r < n$  do  
4:    $r \leftarrow r + 1$   
5:   if  $mate[r] = 0$  then  
6:     for  $i = 1$  to  $m$  do  $parent[i'] \leftarrow 0$   
7:      $Q \leftarrow \emptyset$ ;  $Q.append(r)$ ;  $aug \leftarrow false$ ;  
8:     while  $aug = false$  and  $Q \neq \emptyset$  do  
9:        $x \leftarrow Q.dequeue()$ ;  
10:      for  $y \in A_x$  do  
11:        if  $mate[y] = 0$  then  
12:           $augm(mate, parent, y)$ ;  
13:           $aug \leftarrow true$ ;  
14:           $free \leftarrow free - 1$ ;  
15:        else  
16:          if  $parent[y] = 0$  then  
17:             $parent[y] \leftarrow x$ ;  
18:           $Q.enqueue(mate[y])$ ;
```

...put it into the tree

Algorithm 50 BiMatch($G, match$)

```
1: for  $x \in V$  do  $mate[x] \leftarrow 0$ ;  
2:  $r \leftarrow 0$ ;  $free \leftarrow n$ ;  
3: while  $free \geq 1$  and  $r < n$  do  
4:    $r \leftarrow r + 1$   
5:   if  $mate[r] = 0$  then  
6:     for  $i = 1$  to  $m$  do  $parent[i'] \leftarrow 0$   
7:      $Q \leftarrow \emptyset$ ;  $Q.append(r)$ ;  $aug \leftarrow false$ ;  
8:     while  $aug = false$  and  $Q \neq \emptyset$  do  
9:        $x \leftarrow Q.dequeue()$ ;  
10:      for  $y \in A_x$  do  
11:        if  $mate[y] = 0$  then  
12:           $augm(mate, parent, y)$ ;  
13:           $aug \leftarrow true$ ;  
14:           $free \leftarrow free - 1$ ;  
15:        else  
16:          if  $parent[y] = 0$  then  
17:             $parent[y] \leftarrow x$ ;  
18:             $Q.enqueue(mate[y])$ ;
```

add its buddy to the set
of unexamined leaves