



Modeling and simulations of flame mitigation by fine water spray

Lipyaynen Alexey, Phd student

St-Petersburg State Polytechnic University

JASS 2009



Agenda

- Introduction and objectives
- Model description
 - Gas phase modeling
 - Liquid phase modeling
 - Modeling of injection
- Results of flame suppression by fine water spray
- Effect of initial spray dispersion



Introduction

- Advantages:
 - Water is environmentally friendly and toxically safe extinguishing agent
 - Cheap, clean, available
 - Effective if optimized (may prevent unacceptable damage to protected property)
 - A possible halon (CF_3Br , CF_2BrCl , ...) substitute (such FEA are prohibited)

FEA – Fire Extinguishing Agent

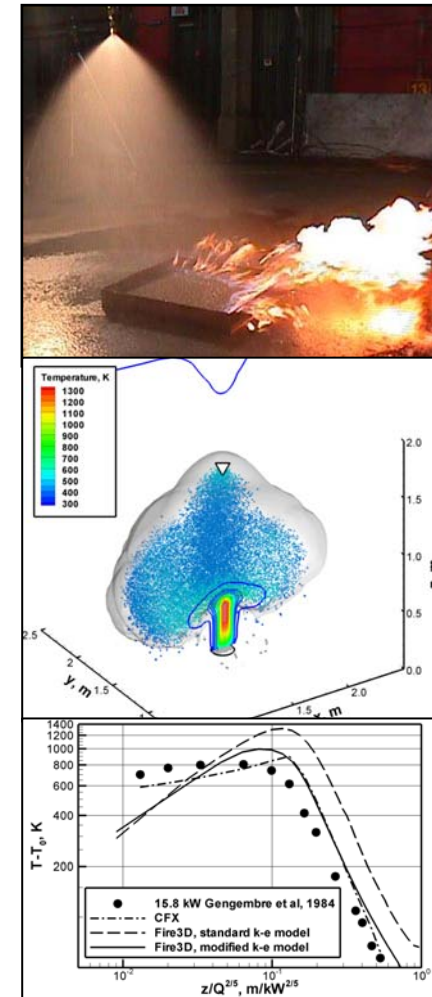



Objectives

- Understanding fundamental mechanisms of the interaction of fine water spray and turbulent diffusion flame
- Development of the appropriate mathematical model of a evaporating spray
- Incorporation of the model into the existing in-house software - Fire3D
- Computational study of interaction of water spray and buoyant turbulent diffusion flame

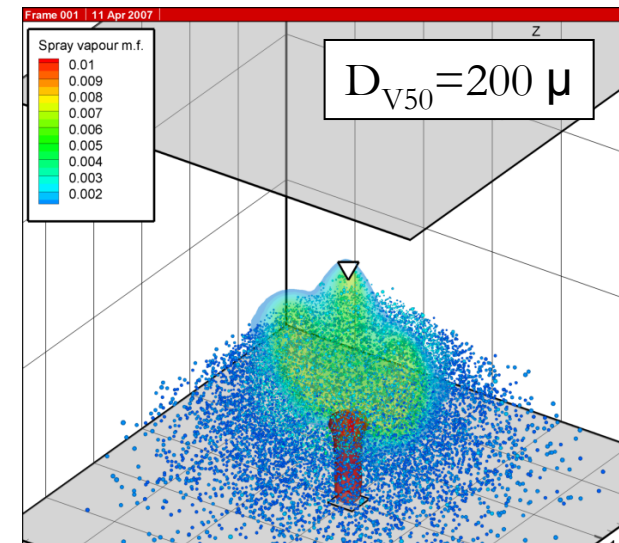



Fine water spray fire suppression

- Initial droplet size is a key parameter that switches extinguishment regimes
- Fine water spray is special: behaves similar to the gas (total flooding) extinguishing agents

G. Grant et al. / Progress in Energy and Combustion Science 26 (2000) 79–130

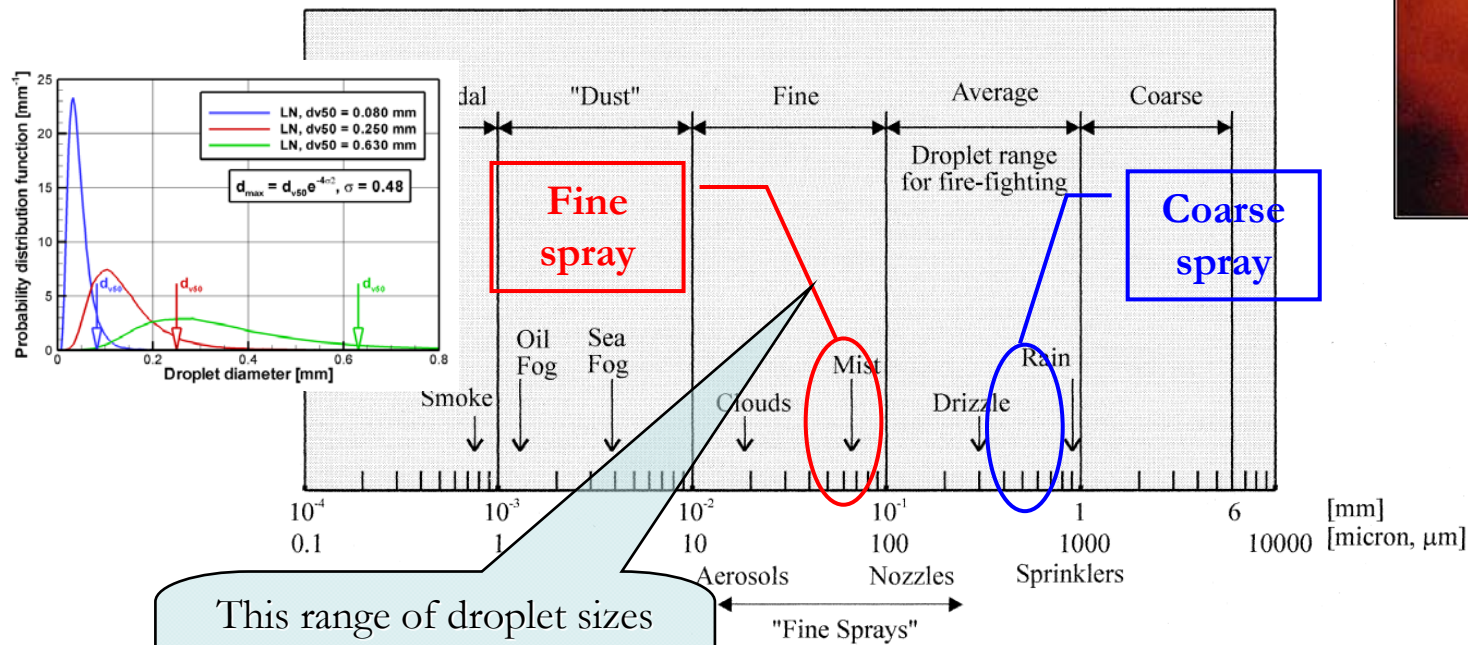

High pressure fine water spray **can** be more efficient

Why and when?



Optimum use of fine water spray

- Two opposite requirements:
 - efficient delivery is needed for **wetting of flame surface**
 - rapid droplet evaporation is required for **cooling of the flame**
- Water spray physics: two droplet delivery regimes
 - Large droplets, coarse spray – **gravity mode** (weak plume-spray interaction, droplet penetration is determined by droplet diameter)
 - Small droplets, fine spray – **momentum mode** (strong plume-spray interaction, penetration may not occur, it is determined by the ratio of spray and plume momentums)
- Optimal solution can't be universal – it depends on a possible fire scenario, geometry etc.
- Need in careful CFD modeling and costly simulations





Model description

Euler-Lagrange approach :

- gas phase – multicomponent reacting mixture
- dispersed phase – large number of droplets

Full interaction assumed (two-way coupling):

- droplet-gas heat transfer
- droplet evaporation (mass transfer)
- momentum exchange
- droplet dispersion due to turbulence



Gas phase modeling

- Navier-Stokes system based on Favre-averaged component, momentum and enthalpy transport equations
- Modified k - ε , eddy break-up and thermal radiation models are used as closing relationships
- Low Mach number flow is considered
- Finite volume technique for discretization

Langman et al, 2007
A – momentary image
B – photo with exposure
(analogue to averaging)

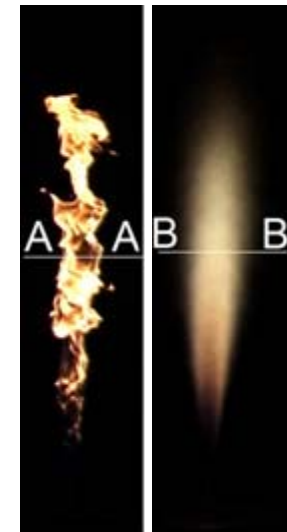



Liquid phase modeling

- Lagrangian approach to model evaporating spray - multiple discrete droplets are tracked along their trajectories in gas-flow with given characteristics
- Momentum, mass, energy conservation equations are considered for groups of similar droplets (**particles**)

Droplet movement due to gravity and drag forces

$$\frac{du_{p,i}}{dt} = -\left(\frac{3\bar{\rho}C_D}{4d_p\rho_p}\right) |u_{p,i} - \tilde{u}_i| (u_{p,i} - \tilde{u}_i) + g_i \left(1 - \frac{\bar{\rho}}{\rho_p}\right) \quad \frac{dx_{p,i}}{dt} = u_{p,i}$$

$$C_D = \begin{cases} 24/\text{Re}_p (1 + 0.15\text{Re}_p^{2/3}) & , \text{Re}_p < 1000 \\ 0.44 & , \text{Re}_p > 1000 \end{cases} \quad \text{Re}_p = \frac{d_p |\tilde{u} - \tilde{u}_p|}{\nu}$$



Droplet dispersion

$$u = \tilde{u} + u' \quad u' = \sqrt{2k/3} \quad l_t = C_\mu^{3/4} k^{3/2} / \varepsilon$$

Particle transit time
through single
examined eddy

$$\tau_p = \begin{cases} -\tau_D \ln \left(1 - \frac{l_t}{\tau_D |\vec{u}_p - \vec{u}_p^*|} \right) & , \text{if } l_t < \tau_D |\vec{u}_p - \vec{u}_p^*| \\ \infty & , \text{if } l_t > \tau_D |\vec{u}_p - \vec{u}_p^*| \end{cases}$$

Interaction time

$$\tau_{p,t} = \min(\tau_p, l_t / \sqrt{2k/3})$$

Turbulence
may have a
considerable
effect!

Heat transfer
from and to
the carrying
gas

Droplet heating

$$m_p C_p \frac{dT_p}{dt} = \begin{cases} q_p + \Delta h_{\text{vap}}(T_p) \frac{dm_p}{dt} & , T_p < T_{\text{boil}} \\ 0 & , T_p = T_{\text{boil}} \end{cases}$$

$$q_p = q_{p,\text{conv}} + q_{p,\text{rad}} \quad q_{p,\text{conv}} = -\pi d_p \text{Nu} \frac{\mu_g}{\text{Pr}} C_{p,g} (T_p - \tilde{T})$$

$$\text{Nu} = 2 + 0.6 \text{Re}_p^{1/2} \text{Pr}^{1/3}$$

Latent heat of
evaporation

$$\Delta h_{\text{vap}}(T_p) = \Delta h_{\text{vap,boil}} + \int_{T_p}^{T_{\text{boil}}} C_p(T) dT$$



Droplet mass loose due to evaporation

$$\frac{dm_p}{dt} = \begin{cases} -\pi d_p \mu_g \frac{Sh}{Pr} \ln(1 + B_m) & , T_p < T_{boil} \\ -\frac{q_p}{\Delta h_{vap}(T_{boil})} & , T_p = T_{boil} \end{cases}$$
$$Sh = 2 + 0.6 Re_p^{1/2} Sc^{1/3}$$
$$B_m = \frac{Y_{vap,sat}(T_p) - Y_{vap,\infty}}{1 - Y_{vap,sat}(T_p)}$$

Inter-phase exchange

$$\bar{r}_M = -\sum \frac{n_p}{\Delta V} \frac{dm_p}{dt}$$

$$\bar{r}_V = -\sum \frac{n_p}{\Delta V} \left(m_p \frac{\bar{u}_p - \tilde{u}}{\tau_D} - \bar{u}_p \frac{dm_p}{dt} \right)$$

$$\bar{r}_H = -\sum \frac{n_p}{\Delta V} \left(m_p C_p \frac{T_p - \tilde{T}}{\tau_T} - h_{vap}(T_p) \frac{dm_p}{dt} \right)$$

$h_{vap}(T_p)$ - is the vapor
enthalpy at droplet
temperature



Modeling of injection

- Sprinkler is modeled here as a point source
- Rosin-Rammler distribution to model polydispersity

$$R(d_p) = \exp\left(-\ln 2 \left(\frac{d_p}{d_{V50}}\right)^\gamma\right)$$

- Velocity vectors uniformly distributed inside the cone

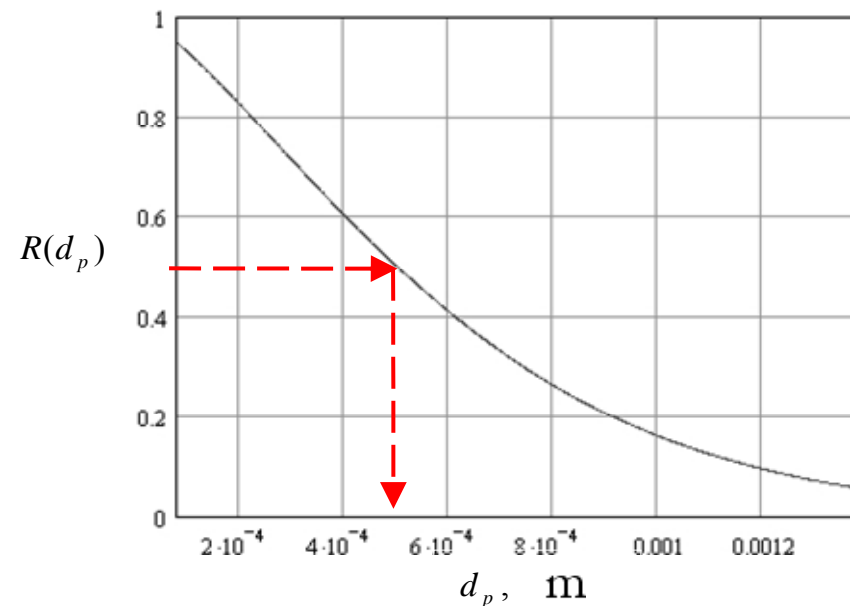



Fine water spray flame suppression

- Schwille & Lueptow experiment
- 15 kW, 18 cm diameter burner, methane
- $d_{v50} = 0.630$ mm
- 3–11.7 l/min
- 120° cone angle, 1.6 m height
- Spray cone is much wider than the flame base

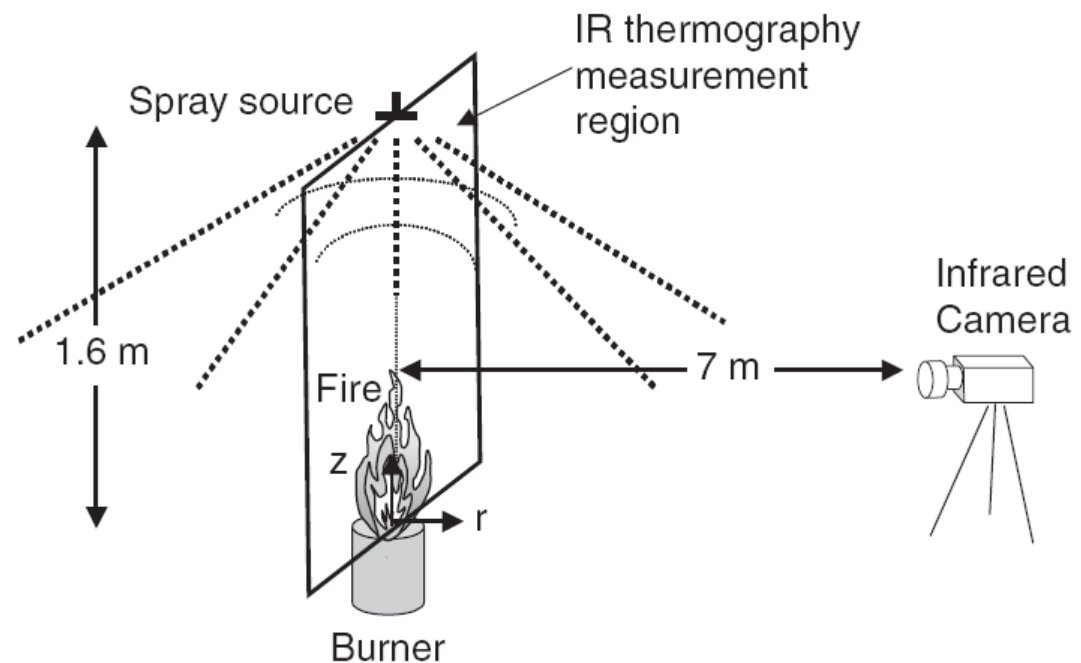

J.A. Schwille, R.M. Lueptow / Fire Safety Journal 41 (2006) 390–398



Flame without water spray

- Comparison with experiments
- Calorific power 15kW

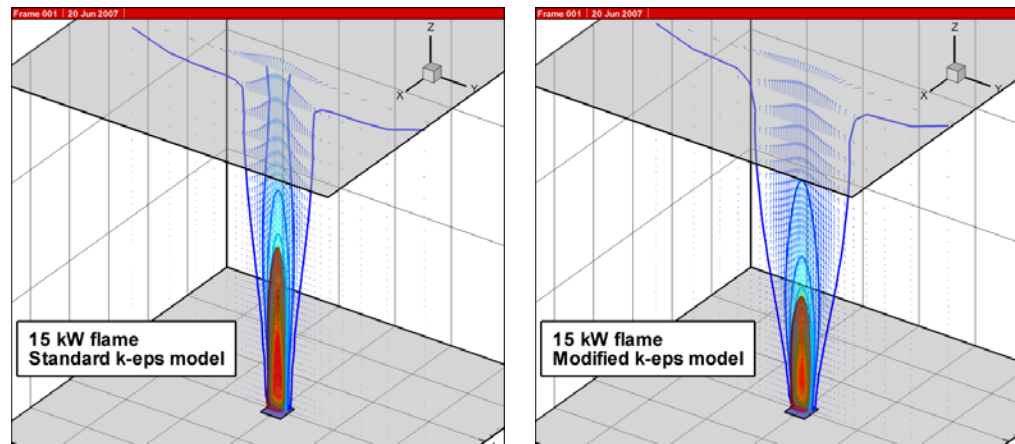

Isosurfaces of temperature $T=200^{\circ}\text{C}$

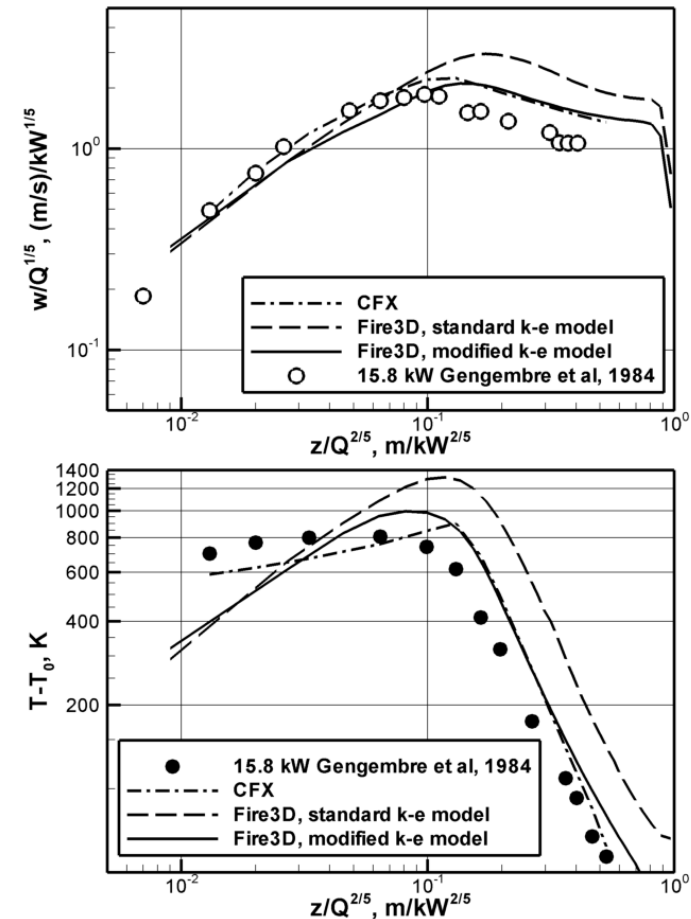

- Transient simulation of the gas flame are then used as initial conditions for case with spray



Fine water spray flame suppression

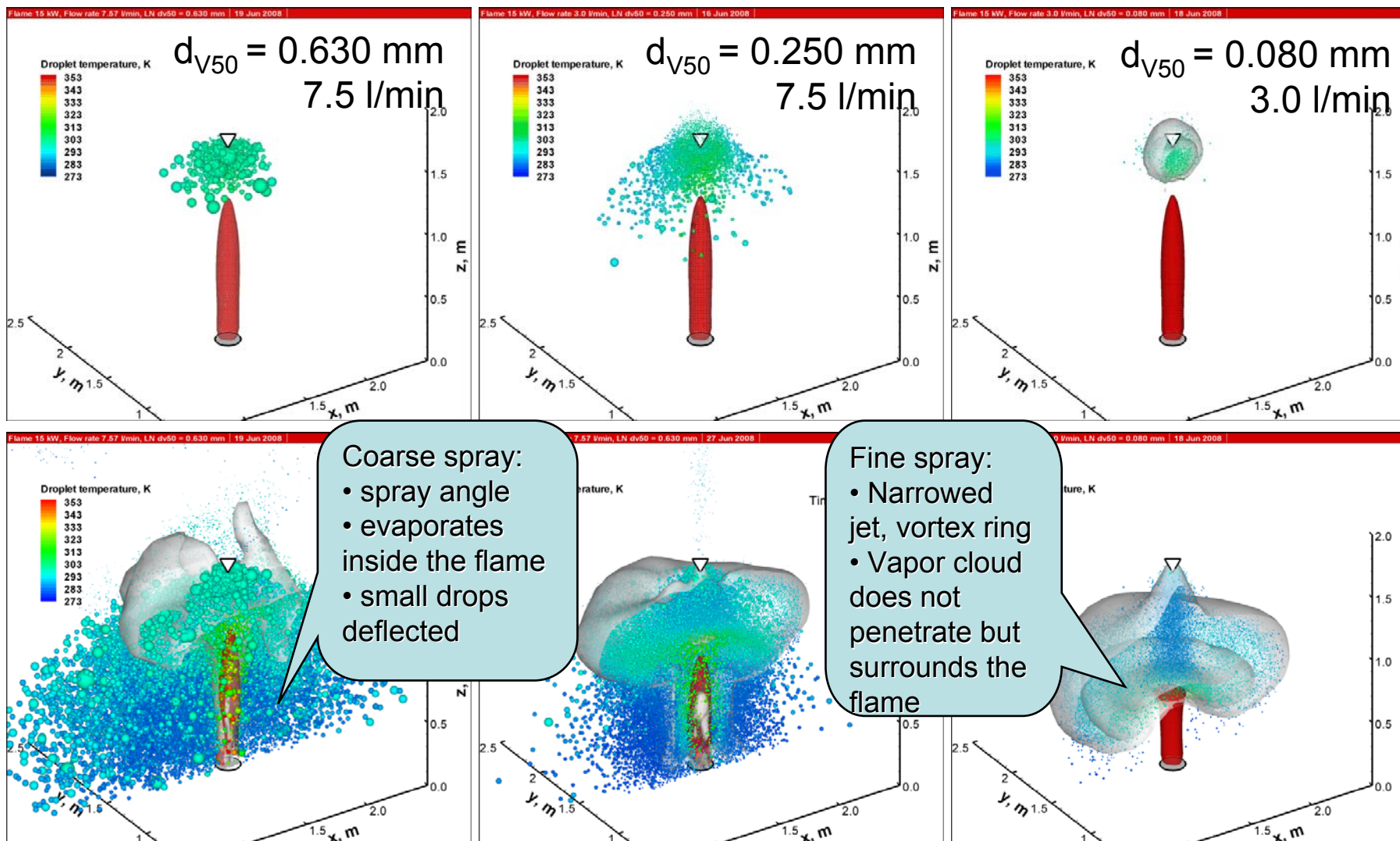



Effect of initial spray dispersion

- Spray dynamics and flame-spray interaction is very sensitive to initial spray dispersion

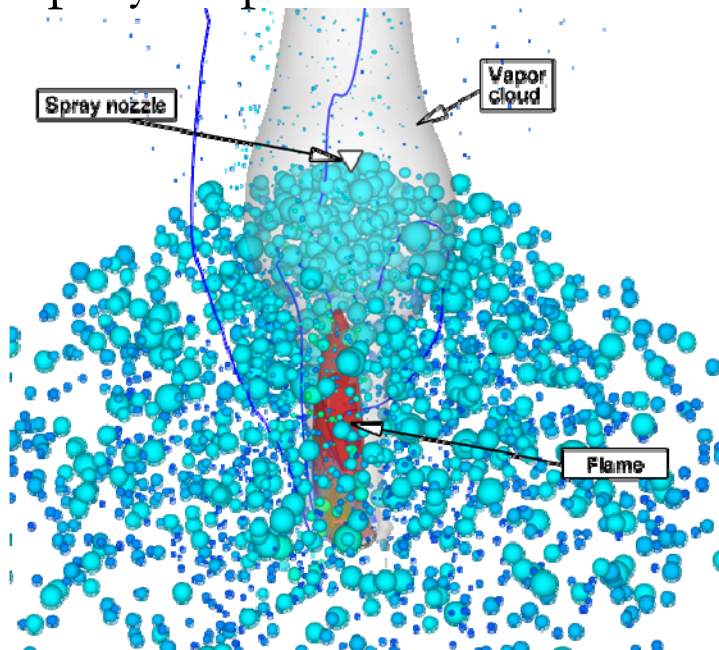

Coarse spray, $d_{V50} = 0.630$ mm
15 kW, 7.57 l/min

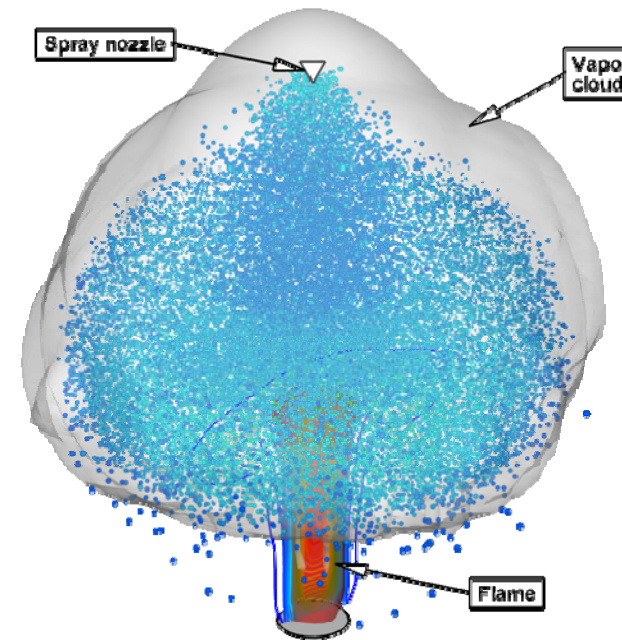

Fine spray, $d_{V50} = 0.080$ mm
15 kW, 7.57 l/min

- Fine spray suppresses flame faster with smaller water supply rate because of: (i) faster evaporation; (ii) higher and more focused momentum



Effect of initial spray dispersion

- The fine spray produces the amount of vapor which is by more than an order of magnitude greater than that produced by the coarse spray
- Fine spray extinguishes the flame within few seconds after the nozzle activation

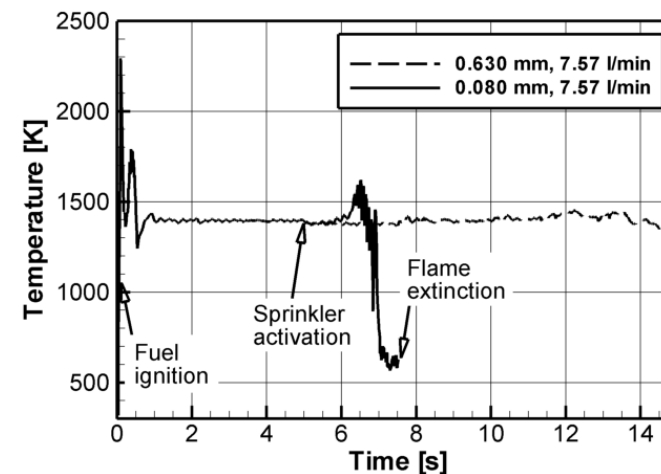
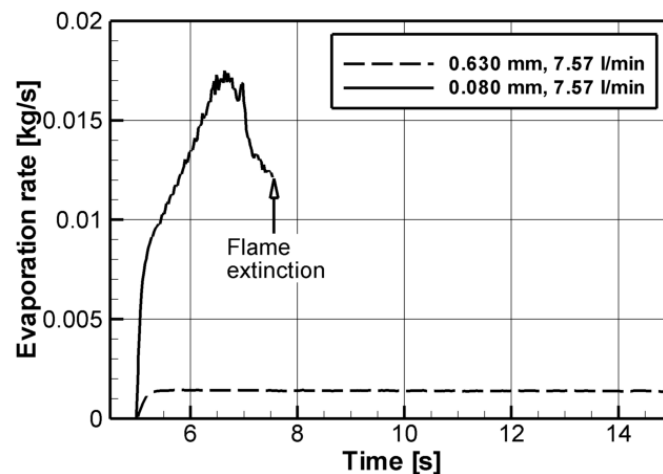



Conclusion

- Model of evaporating spray is developed and incorporated into CFD software
- Mechanisms of spray-flame interaction are identified and demonstrated
- Fine water spray causes faster flame extinguishment with smaller water flow rate



Thank you!

Discussion